

# COLOR EXPERT TRAFALEȚI, ROLE ȘI ACCESORII

Pentru o mai bună și mai rapidă selecție din oferta generoasă, pe lângă imaginile și caracteristicile produselor, găsiți de asemenea pictograme care descriu comportarea articolului folosit și calitățile speciale ale acestuia. Respectivele simboluri se regăsesc și pe ambalajele produselor cu marca COLOR EXPERT.

## I. Recomandarea pentru un anumit tip de vopsea (este valabil pentru pensule și role)



Pentru lacuri cu conținut de solvenți

Pentru lacuri pe bază de apă/ acrilice

Pentru baițuri/ protecție lemn

Pentru vopsele în dispersie, pe bază de latex și pt. fațade

## 2. Alte caracteristici de calitate

Culoarea pictogramei corespunde codului de culoare numit la I. (Pictogramele sunt protejate de legea drepturilor de autor)



**Durabilitate foarte mare**



**Cantitate mare de vopsea aplicată**



**Extra fără scame**



**Extra fără stropire**



**Extra pentru suprafețe rugoase**

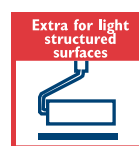

**Extra pentru suprafețe ușor structurate**



**Extra finis foarte uniform**



**Extra curățire rapidă**

## 3. Exemple de prezentare



## 4. Tipuri de pluș

În general sunt valabile următoarele:

- cu cât înălțimea firului este mai mare, cu atât finisul de suprafață este mai grosier, dar și cantitatea de vopsea preluată și randamentul sunt mai mari.
- Blana de miel și lâna asigură un finis de suprafață mai fin decât alte materiale cu aceeași lungime a firului.
- Plușurile țesute lasă mai puține scame decât plușurile tricotate și sunt mai ușor de curățat.
- Deoarece fabricile noastre sunt certificate ISO putem garanta respectarea greutateii date a plușului ( $g/m^2$ ) astfel încât fiecare cumpărător să poată înțelege structurarea prețurilor noastre.

# Role pentru suprafețe mari de la 18 cm lățime și diametru de 40 mm

## Miez pentru inserare etrier

metoda de producție. "pt. vălțuire colțuri" = cusut  
rest= "termofuzionat"= sudat termoplastic sau lipit

Cod art. | Dimensiuni | UV | APG | Descriere

### Miez $\varnothing$ 40 mm, pentru mâner alunecare 8mm

#### Lână (Velur), țesut

84 26 18 20	18 cm	6	B	
84 26 25 20	25 cm	6	B	
84 27 18 20	18 cm	1	B	
84 27 25 20	25 cm	1	B	

1. Fără fig.:  
Lungime fir: 4 mm  
g/m<sup>2</sup>: min. 730  
amestec velur-polieszter

Lungime fir: 4 mm  
g/m<sup>2</sup> min.: 770



1



Lacuri cu conținut de solvenți

#### Poliester, țesut

84 34 18 34	18 cm	5	B	
-------------	-------	---	---	--

2. Lungime fir: 4 mm  
g/m<sup>2</sup> min.: 550  
Fir continuu stabilizat



2



Lacuri pe bază de apă/ acrilice

#### Poliacril, țesut

84 31 18 20	18 cm	1	B	
84 31 25 20	25 cm	1	B	
84 31 45 20	45 cm	1	B	com.specială

3. Lungime fir: 7 mm,  
g/m<sup>2</sup>: min. 640.  
Fir continuu stabilizat

Miez: 47 mm



3



Lacuri pe bază de apă/ acrilice

#### Poliamid, țesut

84 66 18 05	18 cm	6	B	
84 66 23 05	25 cm	6	B	

4. Lungime fir: 12 mm  
g/m<sup>2</sup> min.: 700



4

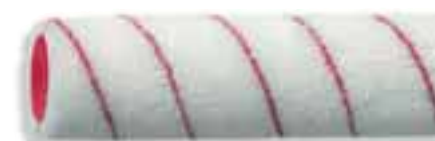

Vopsele în dispersie, pe bază de latex și pt. fațade

### Poliamid, țesut

84 30 19 20	18 cm	5	B	com.specială
84 30 26 20	25 cm	5	B	com.specială

1. Lungime fir: 13 mm  
g/m<sup>2</sup> min.: 930  
ideal pentru vopsele  
epoxidice, acoperiri  
din două  
componente, sigilări



1



Vopsele în dispersie, pe bază de latex și pt. fațade

84 29 18 34	18 cm	5	B	
-------------	-------	---	---	--

2. Lungime fir: 12 mm  
g/m<sup>2</sup> min.: 860  
Ideal pentru vopsele  
dense



2



Vopsele în dispersie, pe bază de latex și pt. fațade

Miez Ø 47 mm, pentru mâner alunecare 8mm

### Poliacril, țesut

84 41 25 20	25 cm	5	B	
-------------	-------	---	---	--

3. Lungime fir: 8 mm,  
g/m<sup>2</sup>: min. 700



3



Lacuri pe bază de apă/ acrilice

### Microfibră, țesut

84 55 18 20	18 cm	5	B	
84 55 25 20	25 cm	5	B	

4. Lungime fir: 9 mm  
g/m<sup>2</sup> min.: 750  
Fir continuu fixat



4



Baițuri/ protecție lemn

### Poliester, tricotat sau țesut

84 15 18 05	18 cm	5	B	com.specială
84 15 25 05	25 cm	5	B	

5. Lungime fir: 18 mm  
g/m<sup>2</sup> min.: 800  
vălțuire colțuri



5



Vopsele în dispersie, pe bază de latex și pt. fațade

Cod art. | Dimensiuni | UV | APG | Descriere

**Poliester, țesut**

84 42 18 10	18 cm	5	B	com.specială
84 42 25 10	25 cm	5	B	

**1.** Lungime fir: 13 mm  
g/m<sup>2</sup> min.: 820  
țesut  
ideal pentru vopsele  
dense,  
adezivi și  
vopsele compacte

**BASIS**  
**QUALITY**

1



Vopsele în dispersie, pe bază de latex și pt. fațade

**Microfibră, țesut**

84 54 25 20	25 cm	5	B	
-------------	-------	---	---	--

**2.** Lungime fir: 7 mm  
g/m<sup>2</sup> min.: 670  
ideal pentru grunduire,  
dispersii  
dense și latex

**TOP**  
**QUALITY**

Extra high capacity



Extra lint free



Extra easy cleaning



2



Vopsele în dispersie, pe bază de latex și pt. fațade

**Poliacril, tricotat sau țesut**

84 52 18 05	18 cm	5	B	
84 52 25 05	25 cm	5	B	

**3.** Lungime fir: 18 mm  
g/m<sup>2</sup> min.: 1000  
tricotat  
vălțuire colțuri

**PROFI**  
**QUALITY**

Extra easy cleaning



3



Vopsele în dispersie, pe bază de latex și pt. fațade

84 52 19 10	18 cm	5	B	com.specială
84 52 26 10	25 cm	5	B	

**4.** Lungime fir: 18 mm  
g/m<sup>2</sup> min.: 1000  
țesut,  
vălțuire colțuri

**PROFI**  
**QUALITY**

Extra long life



Extra easy cleaning



4



Vopsele în dispersie, pe bază de latex și pt. fațade

**Poliamid, țesut**

84 64 18 20	18 cm	5	B	com.specială
84 64 25 20	25 cm	5	B	

**5.** Lungime fir: 20 mm  
g/m<sup>2</sup> min.: 1150

**TOP**  
**QUALITY**

Extra long life



Extra high capacity



Extra easy cleaning



5



Vopsele în dispersie, pe bază de latex și pt. fațade

Cod art.	Dimensiuni	UV	APG	Descriere
84 16 25 20	25 cm	5	B	<b>1.</b> Lungime fir: 13 mm g/m <sup>2</sup> min.: 940 ideal pentru vopsele dense, Rollputz

**TOP**  
**QUALITY**



**1**



**Vopsele în dispersie, pe bază de latex și pt. fațade**

**Lână, țesut**

84 47 18 01	18 cm	I	B	<b>2.</b> Lungime fir: 22 mm g/m <sup>2</sup> min.: 1140 marginii exterioare tăiate
84 47 25 05	25 cm	I	B	

**TOP**  
**QUALITY**



**2**



**Vopsele în dispersie, pe bază de latex și pt. fațade**

**Miez Ø 58 mm, pentru mâner alunecare 8mm**

**Poliester, tricotat**

84 11 18 05	20 cm	5	B	<b>3.</b> Lungime fir: 21 mm g/m <sup>2</sup> min.: 930 căptușit, pt. vălțuire colțuri
84 11 25 05	27 cm	5	B	

**BASIS**  
**QUALITY**



**3**



**Vopsele în dispersie, pe bază de latex și pt. fațade**

**Microfibră, țesut**

84 58 27 34	25 cm	5	B	<b>4.</b> Lungime fir: 15 mm g/m <sup>2</sup> min.: 1000 ideal pentru grunduiri și impregnări

**TOP**  
**QUALITY**



**4**



**Vopsele în dispersie, pe bază de latex și pt. fațade**

I.



**Poliacril, tricotat sau țesut**

84 53 18 05	20 cm	5	B	
84 53 25 05	27 cm	5	B	

**1.** Lungime fir: 18 mm  
g/m<sup>2</sup> min.: 1000  
tricotat  
căptușit, pt. vâlțuire colțuri



1



**Vopsele în dispersie, pe bază de latex și pt. fațade**

84 53 19 10	20 cm	5	B	com.specială
84 53 26 10	27 cm	5	B	com.specială

**2.** Lungime fir: 18 mm  
g/m<sup>2</sup> min.: 1000  
țesut  
căptușit, pt. vâlțuire colțuri



2

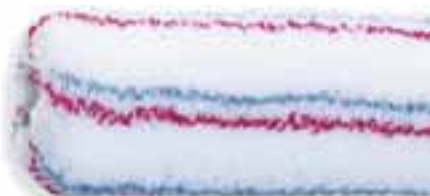

**Vopsele în dispersie, pe bază de latex și pt. fațade**

**Poliamid, țesut**

84 32 18 20	18 cm	5	B	
84 32 25 20	25 cm	5	B	

**3.** Lungime fir: 12 mm  
g/m<sup>2</sup> min.: 860  
condiționat pt. vâlțuire  
colțuri,  
ideal pentru vopsele  
dense, Rollputz



3



**Vopsele în dispersie, pe bază de latex și pt. fațade**

84 62 18 20	20 cm	5	B	
84 62 25 20	27 cm	5	B	

**4.** Lungime fir: 20 mm  
g/m<sup>2</sup> min.: 1150  
căptușit, pt. vâlțuire  
colțuri



4



**Vopsele în dispersie, pe bază de latex și pt. fațade**



**Miez  $\varnothing$  60 mm , pentru mâner alunecare 8mm**

**Poliamid, țesut**

84 28 25 20	25 cm	5	B
-------------	-------	---	---

1. Lungime fir: 21 mm  
g/m<sup>2</sup> min.: 1350  
condiționat pt. vălțuire  
colțuri, fir continuu,  
prelucrat special pentru a  
nu lăsa scame



1



Vopsele în dispersie, pe bază de latex și pt. fațade

**Miez  $\varnothing$  69 mm , pentru mâner alunecare 8mm**

**Poliacril, tricotat**

84 51 18 05	20 cm	6	B
84 51 25 05	27 cm	6	B

2. Lungime fir: 18 mm  
g/m<sup>2</sup> min.: 1000  
căptușit, pt. vălțuire colțuri



2



Vopsele în dispersie, pe bază de latex și pt. fațade

**Poliamid, țesut**

84 63 25 20	27 cm	5	B
-------------	-------	---	---

3. Lungime fir: 20 mm  
g/m<sup>2</sup> min.: 1150  
căptușit, pt. vălțuire colțuri



3



Vopsele în dispersie, pe bază de latex și pt. fațade

84 35 25 20	27 cm	5	B
-------------	-------	---	---

4. Lungime fir: 21 mm  
g/m<sup>2</sup> min.: 1350  
căptușit, pt. vălțuire  
colțuri, fir continuu,  
prelucrat special pentru  
a nu lăsa scame





4



Vopsele în dispersie, pe bază de latex și pt. fațade





## Trafalet și seturi complete, miez de la 40 mm la 58 mm

### Lână (Velur), țesut

85 86 15 05	15 cm	5	B		<b>1.</b> Mieș: 40 mm Lungime fir: 4 mm g/m <sup>2</sup> min.: 700 etrier fix pentru etrier: 6mm	 		1

Lacuri cu conținut de solvenți

### Poliester, țesut



84 75 15 01	15 cm	5	B	com.specială	<b>2.</b> Mieș: 40 mm Lungime fir: 6 mm g/m <sup>2</sup> min.: 560 etrier fix pentru etrier: 6mm	  		2

Lacuri pe bază de apă/ acrilice

### Poliester, tricotat

85 90 19 10	18 cm	10	C		<b>3.</b> Mieș: 40 mm Lungime fir: 18 mm g/m <sup>2</sup> min.: 570 etrier fix pentru etrier: 6mm set cu grătar plastic 18x32 cm			3
85 90 20 27	18 cm	10	C					
85 90 23 10	23 cm	10	C					

Vopsele în dispersie, pe bază de latex și pt. fațade

85 92 23 99	23 cm	8	C		<b>4.</b> Mieș: 40 mm Lungime fir: 18 mm g/m <sup>2</sup> min.: 570 etrier detașabil pentru etrier: 6mm set cu tavă plastic 26x32 cm			4

Vopsele în dispersie, pe bază de latex și pt. fațade

86 83 65 01	23 cm	I	B	com.specială	<b>5.</b> Trafalet cu pompă cu sistem de prelungire și aspirare, rolă alimentată prin interior, rezervor de vopsea în mână, cantitate de umplere 520 ml Rolă: mieș 40 mm Lungime fir: 12 mm			5   6
86 83 99 99	23 cm	I	B	com.specială				

Vopsele în dispersie, pe bază de latex și pt. fațade



**Poliacril, tricotat**

84 98 75 99	27 cm	I	B
-------------	-------	---	---

- 1. Trafalet EXTRA REACH,**  
Miez 58 mm  
Lungime fir: 18mm  
g/m<sup>2</sup> min.: 1000,  
pt. vâlțuire colțuri  
etrier telescopic cu mâner  
"soft-grip" cu mecanism  
de extindere cu 2 trepte  
Lungime 44 – 90cm

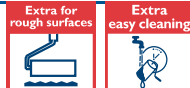

1



Vopsele în dispersie, pe bază de latex și pt. fațade

**Role pentru suprafețe mici, miez 15/16 mm și 30 mm,  
Pentru etrier inserat de 6 mm**

**Role de lăcuire (role de spumă și role cu o lungime a firului de până la 8 mm)**

**Miez de 15/ 16 mm**

**Polyether, diametru exterior 35 mm, structură "fină"**

86 70 05 10	1x5 cm	20	B
86 70 11 10	1x11 cm	10	B
86 70 16 10	1x16 cm	10	B

- 2. Capete drepte pe ambele părți,**  
ambalate individual



2



Lacuri cu conținut de solvenți

86 70 30 20	2x5 cm	10	B
86 70 31 01	2x7 cm	10	B
86 70 71 01	2x11 cm	10	B
86 70 76 20	2x16 cm	10	B
			com.specială
86 70 50 99	10x5 cm	1	B
86 70 40 99	10x11 cm	5	B
			com.specială

- 3. capete drepte**  
blister 2 buc



3

Pachet 10 buc



Lacuri cu conținut de solvenți

**Spumă poliesterică, diametru exterior 35 mm structură "superfină"**

86 74 11 10	1x11 cm	10	B
86 74 16 05	1x16 cm	10	B
86 74 41 01	2x11 cm	10	B

- 4. Capete rotunjite pe ambele părți**  
ambalate individual



4

Pachet 2 buc



Lacuri cu conținut de solvenți

Cod art. | Dimensiuni | UV | APG | Descriere

**Spumă poliestică, diametru exterior 50 mm structură "superfină"**

86 78 16 99	16 cm	10	B		1. Capete rotunjite pe ambele părți ambalate individual	TOP QUALITY	Extra fine finish		1

Lacuri cu conținut de solvenți

**Lână (Velur), țesut**

86 50 10 10	1x10 cm	10	B		2. Lungime fir: 4 mm g/m <sup>2</sup> min.: 770 ambalate individual	TOP QUALITY	Extra fine finish		2
86 50 15 27	1x15 cm	10	B		ambalate individual blister				
86 50 30 99	2x6 cm	10	B		Pachet 2 buc				
86 50 70 01	2x10 cm	10	B		Pachet 2 buc				
86 50 40 99	10x10 cm	1	B	com.specială	Pachet 10 buc				
86 50 80 99	20x6 cm	1	B	com.specială	Pachet 20 buc				

Lacuri cu conținut de solvenți

**Poliester, țesut**

86 60 10 10	10 cm	10	B		3. Lungime fir: 4 mm g/m <sup>2</sup> min.: 550 fir continuu scămoșat, stabilizat, ideal pentru lacuri acrilice pe bază de apă și lacuri pe bază de ulei, ambalat individual	PROFI QUALITY		3

Lacuri pe bază de apă/ acrilice

**Poliacril, țesut**

86 41 10 10	10 cm	10	B	com.specială	4. Lungime fir: 8 mm, g/m <sup>2</sup> : min. 700	PROFI QUALITY		4

Lacuri pe bază de apă/ acrilice

**Poliamid, țesut**

86 35 10 10	10 cm	10	B		5. Lungime fir: 7 mm g/m <sup>2</sup> min.: 640 fir continuu stabilizat blister, ideal pentru sigilări parchet, ambalat individual, blister	TOP QUALITY	Extra lint free		5

Lacuri pe bază de apă/ acrilice

**Spumă poliestică plușată, diametru exterior 35 mm**

86 76 07 05	7 cm	10	B		6. Capete rotunjite, ambalat individual, blister	TOP QUALITY	Extra fine finish		6
86 76 11 05	11 cm	10	B						
86 76 16 05	16 cm	10	B						

Lacuri pe bază de apă/ acrilice

## Miez 30 mm, lipit

### Velur, țesut

86 51 10 10	10 cm	10	B	
-------------	-------	----	---	--

1. Lungime fir: 4 mm,  
g/m<sup>2</sup>: min. 730.

TOP  
QUALITY



1



Lacuri cu conținut de solvenți

## Role (cu lungimea firului de peste 8 mm)

### Diametru miez 15/ 16 mm

### Microfibră

86 52 11 10	1x10 cm	10	B	com.specială
86 52 10 01	2x10 cm	10	B	

2. Lungime fir: 9 mm  
g/m<sup>2</sup> min.: 675  
fir continuu fixat,  
ambalat individual

blister 2 buc

TOP  
QUALITY



2



Baițuri/ protecție lemn

### Poliester, țesut

86 40 11 10	10 cm	10	B	com.specială
-------------	-------	----	---	--------------

3. Lungime fir: 13 mm  
g/m<sup>2</sup> min.: 820  
ambalat individual

BASIS  
QUALITY

3



Vopsele în dispersie, pe bază de latex și pt. fațade

### Poliacril, țesut

86 37 10 10	1x10 cm	10	B	
86 37 15 99	2x6 cm	10	B	
86 37 40 01	2x10 cm	10	B	
86 37 41 99	10x10 cm	1	B	com.specială

4. Lungime fir: 12 mm  
g/m<sup>2</sup> min.: 720  
ambalat individual

blister 2 buc

Pachet 10 buc

PROFI  
QUALITY



4



Vopsele în dispersie, pe bază de latex și pt. fațade

### Microfibră, țesut

86 58 10 10	1x10 cm	10	B	com.specială
-------------	---------	----	---	--------------

5. Lungime fir: 15 mm  
g/m<sup>2</sup> min.: 1000  
cusut  
Ideal pentru grunduri și  
impregnări  
ambalat individual

TOP  
QUALITY



5



Vopsele în dispersie, pe bază de latex și pt. fațade

## Poliamid, țesut

Cod art.	Dimensiuni	UV	APG	Descriere	TOP QUALITY	Extra long life	max	1
86 31 10 10	1x10 cm	10	B	1. Lungime fir: 12 mm g/m <sup>2</sup> min.: 860 ambalat individual	TOP QUALITY	Extra long life	max	
86 31 15 05	1x15 cm	10	B	ambalat individual, blister				
86 31 40 01	2x10 cm	10	B	blister 2 buc				

Vopsele în dispersie, pe bază de latex și pt. fațade

Cod art.	Dimensiuni	UV	APG	Descriere	TOP QUALITY	Extra long life	Extra lint free	2
86 33 09 10	1x10 cm	10	B	2. Lungime fir: 13 mm g/m <sup>2</sup> min.: 900 ideal pentru vopsele epoxidice, acoperiri din două componente, sigilări ambalat individual	TOP QUALITY	Extra long life	Extra lint free	
86 33 15 99	1x15 cm	10	B	com.specială ambalat individual blister				
86 33 40 01	2x10 cm	10	B	blister 2 buc				

Vopsele în dispersie, pe bază de latex și pt. fațade

Cod art.	Dimensiuni	UV	APG	Descriere	TOP QUALITY	Extra long life	Extra high capacity	Extra easy cleaning	3
86 28 10 10	1x10 cm	10	B	3. Lungime fir: 13 mm g/m <sup>2</sup> min.: 940 fir continuu, prelucrat fără scame ambalat individual	TOP QUALITY	Extra long life	Extra high capacity	Extra easy cleaning	

Vopsele în dispersie, pe bază de latex și pt. fațade

## Miez 30 mm, lipit

## Poliamid, țesut

Cod art.	Dimensiuni	UV	APG	Descriere	TOP QUALITY	Extra lint free	4
86 35 50 01	10 cm	10	B	com.specială 4. Lungime fir: 7 mm g/m <sup>2</sup> min.: 640 fără fir continuu, stabilizat, ideal pentru sigilări parchet ambalat individual, blister	TOP QUALITY	Extra lint free	

Lacuri pe bază de apă/ acrilice

### Microfibră, țesut

86 52 30 05	1x10 cm	10	B	
-------------	---------	----	---	--

1. Lungime fir: 9 mm  
g/m<sup>2</sup> min.: 675  
fir continuu, fixat  
ambalat individual, blister



1



Baițuri/ protecție lemn

### Poliacril, țesut

86 36 10 05	1x10 cm	10	B	
86 36 40 99	10x10 cm	1	B	com.specială

2. Lungime fir: 12 mm  
g/m<sup>2</sup> min.: 720  
ambalat individual blister



2

Pachet 10 buc



Vopsele în dispersie, pe bază de latex și pt. fațade

### Poliamid, țesut

86 32 15 01	15 cm	10	B	com.specială
-------------	-------	----	---	--------------

3. Lungime fir: 12 mm  
g/m<sup>2</sup> min.: 860  
ambalat individual, blister



3



Vopsele în dispersie, pe bază de latex și pt. fațade

### Trafaletți pentru suprafețe mici și seturi

#### Spumă poliesterică, structură "fină"

86 96 05 20	5 cm	10	B	
86 84 11 20	11 cm	10	B	

4. Rolă: margini drepte  
etrier 19 cm



4

5

5. Rolă: margini drepte  
etrier 29 cm



Lacuri cu conținut de solvenți

Cod art.	Dimensiuni	UV	APG	Descriere
86 91 05 20	5 cm	10	C	<b>1.</b> Set cu 3 comp: Rolă: margini drepte, etrier 19 cm Tăviță: 12x23 cm.
86 90 11 20	11 cm	10	C	

**BASIS**  
QUALITY

**1**

**2**



Lacuri cu conținut de solvenți

86 93 30 20	10 cm	10	B	<b>3.</b> Set cu 3 componente: Rolă: velur 30mm, etrier 29 cm Tăviță: 15x32 cm
86 94 11 05		10	C	

**PROFI**  
QUALITY

**3**

**4**



Lacuri cu conținut de solvenți

**Spumă poliesterică, structură "superfină"**

86 97 16 05	16 cm	5	B	<b>5.</b> capete rotunjite pe ambele părți exterior $\varnothing$ 50 mm cu etrier detașabil: 6mm

**TOP**  
QUALITY

Extra high capacity

Extra fine finish

**5**



Lacuri cu conținut de solvenți

**Spumă poliesterică, plușată**

86 76 29 99	11 cm	10	B	<b>6.</b> capete rotunjite pe ambele părți Mâner: 29 cm
86 92 11 99	11 cm	10	C	

**TOP**  
QUALITY

Extra fine finish

**6**

**7**



Lacuri pe bază de apă/ acrilice



### Microfibră, țesut

86 52 50 05	10 cm	10	B	
86 52 70 05	10 cm	10	B	

1. Lungime fir: 9 mm  
g/m<sup>2</sup> min: 675  
Miez 16 mm  
Mâner: 29 cm
2. Set cu 3 comp:  
Lungime fir: 9 mm  
g/m<sup>2</sup> min: 675  
Miez 16 mm  
Mâner: 29 cm  
Tăviță: 15 x 32 cm



1

2



Baițuri/ protecție lemn

### Poliacril

86 98 10 99	10 cm	10	B	
86 98 39 99	10 cm	5	B	com.specială
86 98 40 05	10 cm	10	C	

3. Lungime fir: 12 mm  
g/m<sup>2</sup> min: 720  
Miez 15 mm  
Mâner: 29 cm
4. Lungime fir: 12 mm  
g/m<sup>2</sup> min: 720  
Miez 30 mm  
Mâner: 39 cm
5. Set cu 3 comp:  
Lungime fir: 12 mm  
g/m<sup>2</sup> min: 700  
Miez 15 mm  
Mâner: 29 cm  
Tăviță: 15 x 32 cm.



3

4

5



Vopsele în dispersie, pe bază de latex și pt. fațade

### Dispozitive pentru utilizări speciale

84 84 11 20	115x80 mm	I	B	com.specială
84 84 12 44	115x80 mm	I	B	com.specială
86 83 11 01	10 cm	I	B	com.specială
86 80 39 27		5	B	
86 80 40 27		5	B	
86 82 99 01		I	B	com.specială
86 82 10 99		I	B	com.specială

6. Dispozitiv pentru vopsit canturi  
D/NL/F/I  
Fără fig:  
rezervă pentru dispozitivul de vopsit canturi  
D/NL/F/I
7. Trafalet tăiat poliamid,  
lungime fir 12 mm
8. Trafalet colțuri  
Poliacril  
Lungime fir: 12 mm  
Mâner: 39 cm.  
  
Fără fig:  
Rezervă pentru trafalet colțuri.
9. Trafalet vopsit țevi  
Poliamid  
Mâner: 39 mm  
  
Fără fig:  
Rola de schimb pt. trafalet vopsit țevi



6

7

8

9



Vopsele în dispersie, pe bază de latex și pt. fațade





Cod art.	Dimensiuni	UV	APG	Descriere
----------	------------	----	-----	-----------

**Trafaleți structură, pentru mâner de 8mm**

86 71 25 20	25 cm	5	B	com.specială	<b>1. Structură grosieră</b> Ø 75 mm		<b>1</b>

**Rolă structurat, etrier fix 6 mm**

85 88 19 27	18 cm	I	B		<b>2. Structură grosieră</b> Ø 75 mm		<b>2</b>
85 89 19 27	18 cm	I	B		<b>3. "Bob de mazăre"</b> Ø 75 mm		<b>3</b>



**Rolă cu țepi, miez 45 mm, etrier fix 8 mm**

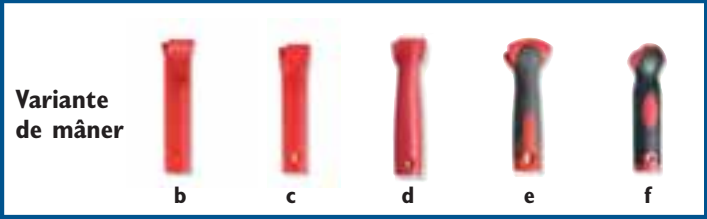

86 94 24 99	24 cm	I	B		<b>4. Cu țepi din plastic</b> de 11 mm, ideal pentru nivelarea materialelor cu viscozitate ridicată (mase de nivelare, șape)		<b>4</b>

**Mânere pentru trafaleți pentru role pt. suprafețe mari și role pt. suprafețe mici**



**Pentru role pt. suprafețe mari cu lățimea rolei: 18 – 27cm, etrier de 8 mm**

84 00 18 99	18 cm	10	C		<b>5. Varianta de mâner: b</b> tijă telescopică		<b>5</b>
84 00 25 99	25 cm	10	C				
84 07 18 99	18 cm	10	C	com.specială	<b>6. Varianta de mâner: d</b> Mâner Komfort cu întăritură pentru folosire îndelungată, tijă telescopică		<b>6</b>
84 07 25 99	25 cm	10	C	com.specială			

84 05 07 10	18 cm	10	C	com.specială	<b>7. Varianta de mâner: f</b> Mâner cu 2 componente		<b>7</b>
84 05 10 10	25 cm	10	C	com.specială			
84 05 18 10	18 cm	10	C		<b>8. Varianta de mâner: e</b> Mâner cu 2 componente pentru folosire îndelungată, tijă telescopică		<b>8</b>
84 05 25 10	25 cm	10	C				

### Mâner special



85 05 45 10	32-58 cm	I	C	com.specială	<p><b>1. Etrier Jumbo pentru role foarte late</b> Varianta de mâner: b</p>		1
-------------	----------	---	---	--------------	--	--	---

### Pentru role pt. suprafețe mici cu lățimea rolei: 5 – 16 cm, etrier de 6mm



86 00 19 99	19 cm „b”	10	C		<p><b>2. Varianta de mâner: b,c</b> Pentru lățime rolă 5-7 cm</p>	2	3	4	5	6
86 01 19 10	19 cm „c”	10	C							
86 00 29 99	29 cm „b”	10	C		<p><b>3. Varianta de mâner: b,c</b> Pentru lățime rolă 10-16 cm.</p>					
86 01 29 10	29 cm „c”	10	C							
86 00 39 99	39 cm „b”	10	C		<p><b>4. Varianta de mâner: b,c</b> Pentru lățime rolă 10-16 cm</p>					
86 01 39 10	39 cm „c”	10	C							
86 04 39 10	39 cm „e”	10	C	com.specială	<p><b>5. Varianta de mâner: e</b> Pentru lățime rolă 10-16 cm.</p>					
86 00 56 99	56 cm „b”	10	C	com.specială						
					<p><b>6. Varianta de mâner: b</b> Pentru lățime rolă 10-16 cm</p>					

### Alte accesorii pentru vopsire

#### Recipienți

84 83 80 10		10	A	com.specială	<p><b>7. Recipient pensule cu capac.</b> Capacitate: 700 ml</p>	7	8
84 83 50 27		20	B				
					<p><b>8. Expert Cup</b> Vas cu mâner pentru curățat role mici și pensule. Capacitate: 2 litri</p>		

#### Grătare

84 83 40 10	18x20 cm	10	C		<p><b>9. Plastic.</b></p>	9	10
84 83 29 10	21x25 cm	10	C				
84 83 28 10	26x28 cm	10	C				
84 83 27 10	26x30 cm	10	A		<p><b>10. Metal (zincat)</b></p>		

Cod art. | Dimensiuni | UV | APG | Descriere

**Tăvițe vopsea**

84 80 11 05	15x32 cm	10	C	
84 80 12 05	20x22 cm	10	C	
84 80 18 05	26x32 cm	10	C	
84 80 25 05	32x36 cm	10	C	
84 80 30 10	30x47 cm	15	C	

**1.** Tăvițe vopsea,  
Plastic

**2.** Tăviță vopsea,  
Plastic, perete gros

**Găleță vopsea, suport magnetic instrumente**

84 82 08 10	8 l	I	C	
84 82 14 10	12 l	I	C	
84 82 44 10	14 l	I	C	com.specială
84 89 10 37		20	B	

**3.** Găleată vopsea,  
plastic,  
dreptunghiulară cu  
perete lateral renurată

**4.** Suport magnetic instrumente  
cu deschizător de cutii.  
Se poate fixa pe cutii de  
vopsea, găleți și pe vasul  
Expert Cup.

**Tije de prelungire, reglabile telescopic****Oțel**

84 90 13 20	130 cm	10	B	
84 90 20 20	200 cm	10	B	
84 90 30 20	300 cm	10	B	

**5.** Tija telescopică  
reglabilă la alegere  
diametru exterior  
25 mm

**Aluminiu**

84 92 00 27	200 cm	6	B	
84 93 00 01	300 cm	6	B	

**6.** Tija telescopică,  
cu clemă de prindere pt  
mâner



84 96 22 95	220 cm	I	B	com.specială
-------------	--------	---	---	--------------

**7.** Tija telescopică,  
cu clemă de prindere pt  
mâner, aluminiu – fibră  
de sticlă

**Mixere**

94 30 10 27	10 kg	6	C	
94 30 15 27	15 kg	3	C	
94 30 20 27	20 kg	3	C	

**8.** Mixer rotund  
60 x 400 mm,  
Până la 10 kg

85 x 400 mm,  
Până la 15 kg

100 x 600 mm,  
Până la 20 kg



Pentru alte tipuri de mixere, consultați catalogul: pag 54 și 82